

cattelanitalia.com

**cattelan
italia**

ARSENAL

**ISTRUZIONI DI MONTAGGIO ASSEMBLING INSTRUCTIONS MONTAGEANLEITUNG
INSTRUCTIONS DE MONTAGE INSTRUCCIONES DE MONTAJE**

IMPORTANTE: Riporre per eventuali consultazioni future!!!!

IMPORTANT: File for future consultation!!!!

WICHTIG: Bitte aufbewahren für eventuelle spätere Nachfragen!!!!

IMPORTANT: A conserver pour les futurs besoins de reference!!!!

¡IMPORTANTE: Guardar para consultas posteriores!

ARSENAL A - B

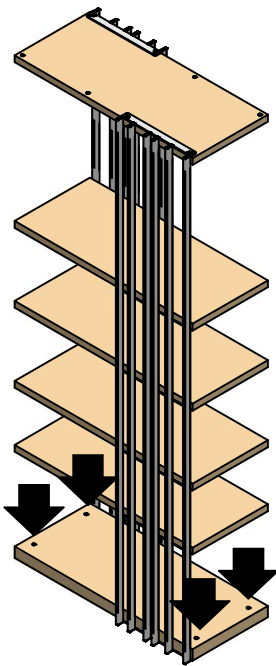
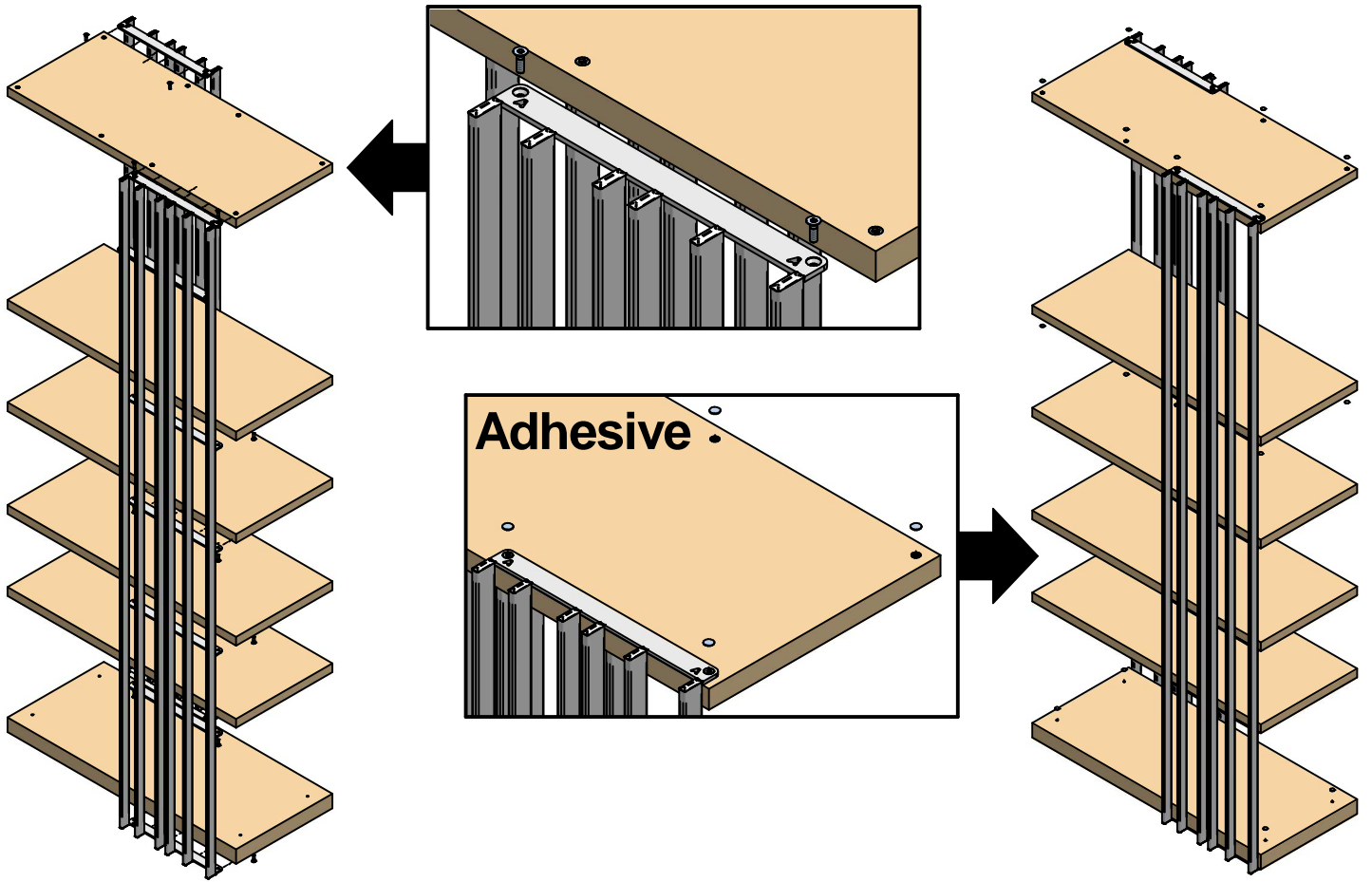

Livellare la libreria rispetto al pavimento.
 Level the library relative to the floor.
 Richten Sie die Bibliothek gegenüber dem Boden.
 Nivelar le rapport bibliothèque à l'étage.
 Nivel de la biblioteca en relación al suelo.

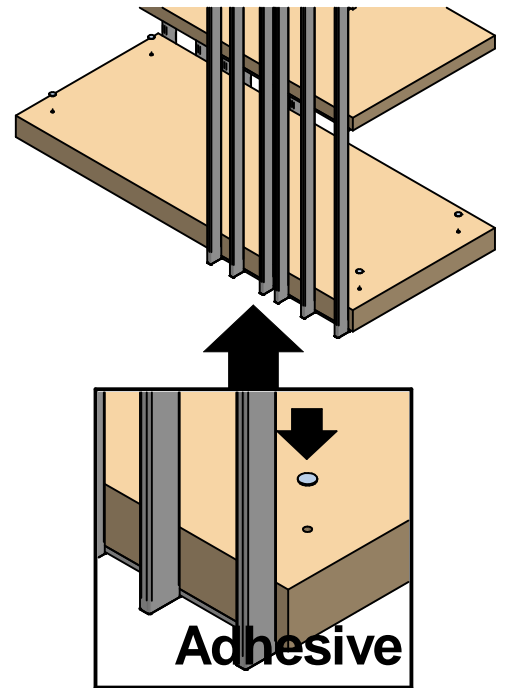
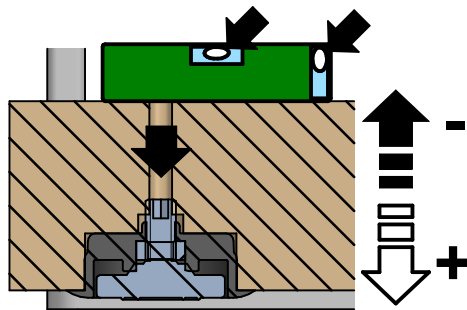

n° 24 TPSCE M6x25 ZB.



n° 44 adhesive ø13x1.



n° 01 da 04.

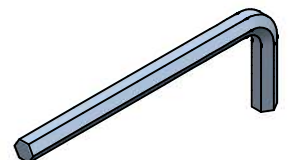

ARSENAL A - B

ARSENAL A DX - RH

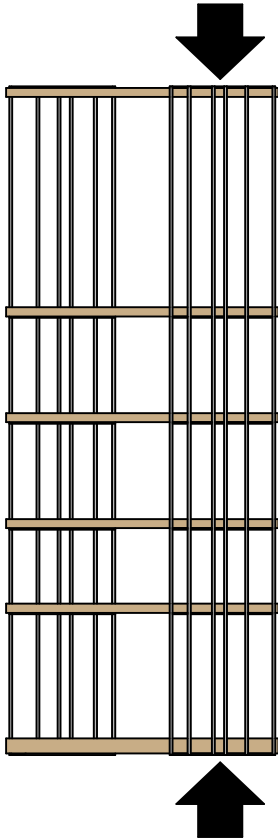

SX - LH

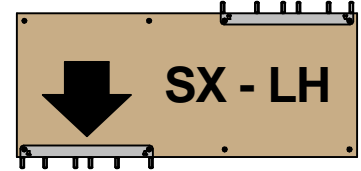
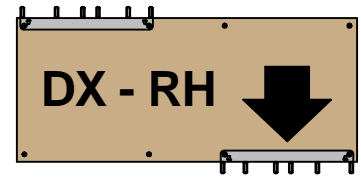
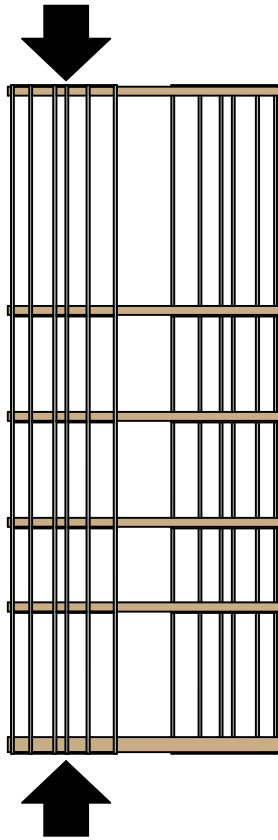

ARSENAL B DX - RH

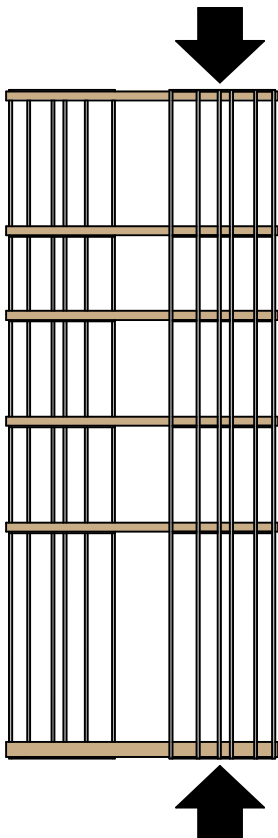

SX - LH

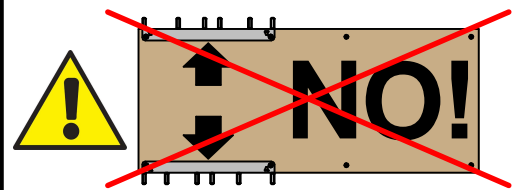

ARSENAL A



NO!

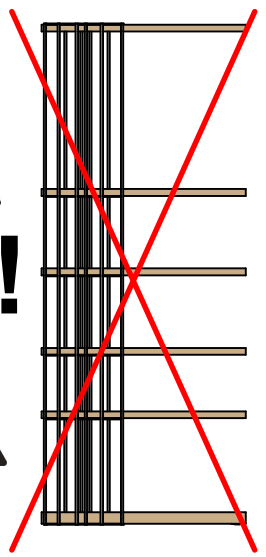

ARSENAL B



NO!

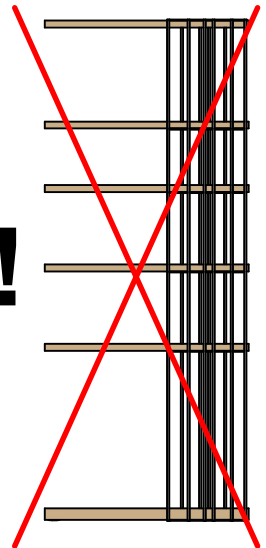

ARSENAL C

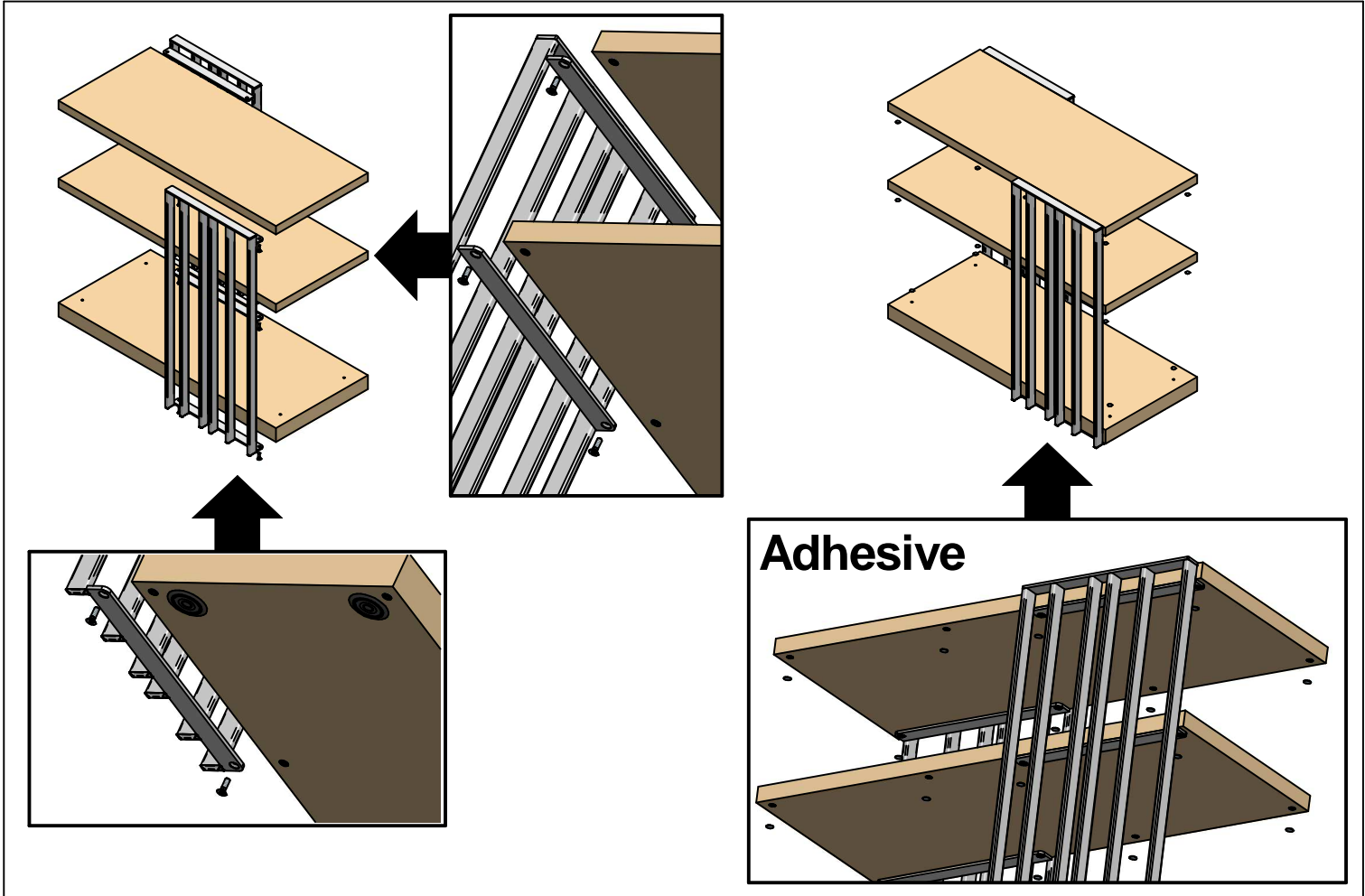

Livellare la libreria rispetto al pavimento.

Level the library relative to the floor.

Richten Sie die Bibliothek gegenüber dem Boden.

Niveler le rapport bibliothèque à l'étage.

Nivel de la biblioteca en relación al suelo.

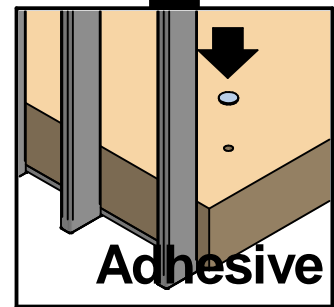
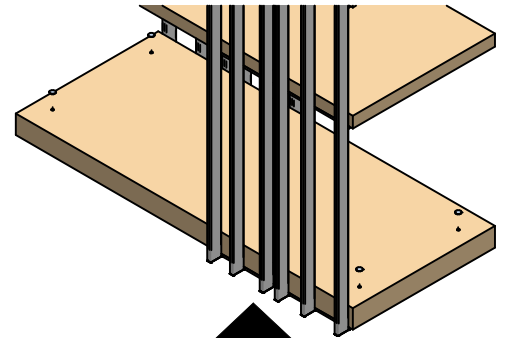
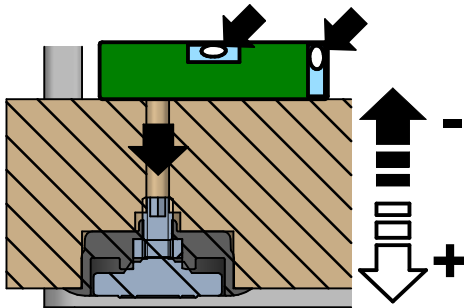
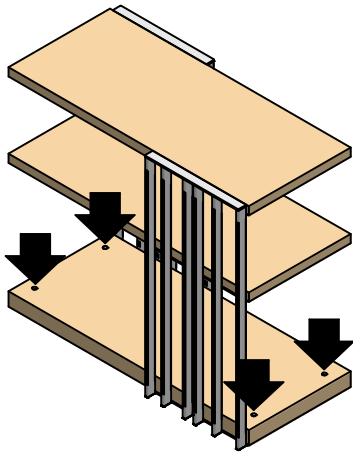

n° 12 TPSCE M6x25 ZB.



n° 20 adhesiveø13x1.

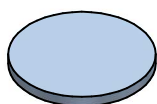

n° 01 da 04.

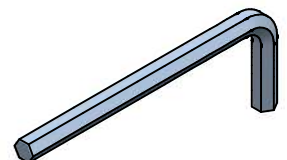

ARSENAL C

DX - RH

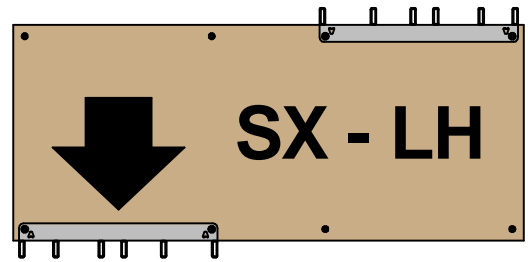
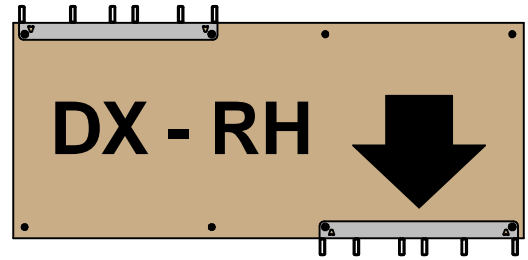
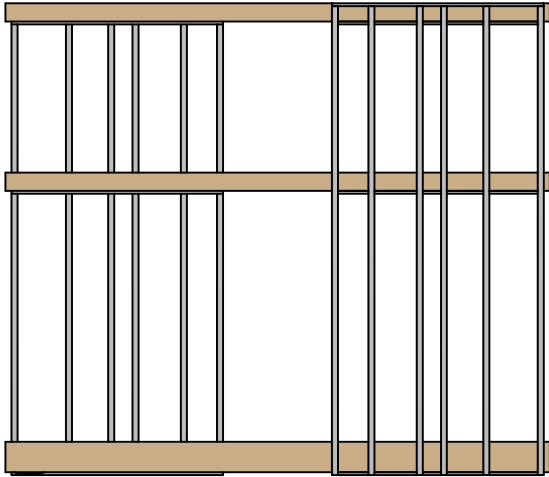

SX - LH

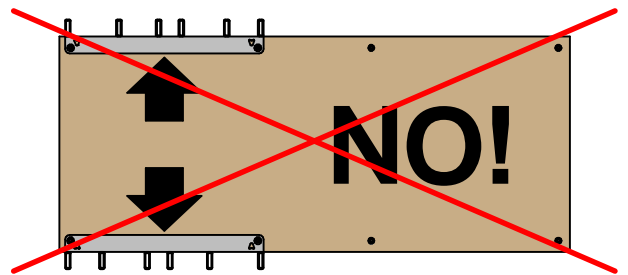
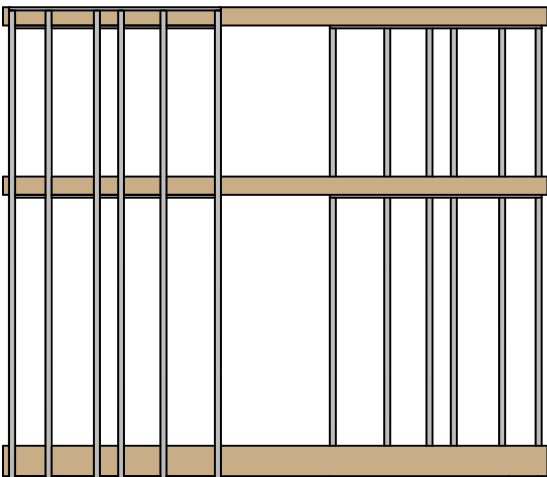

NO!

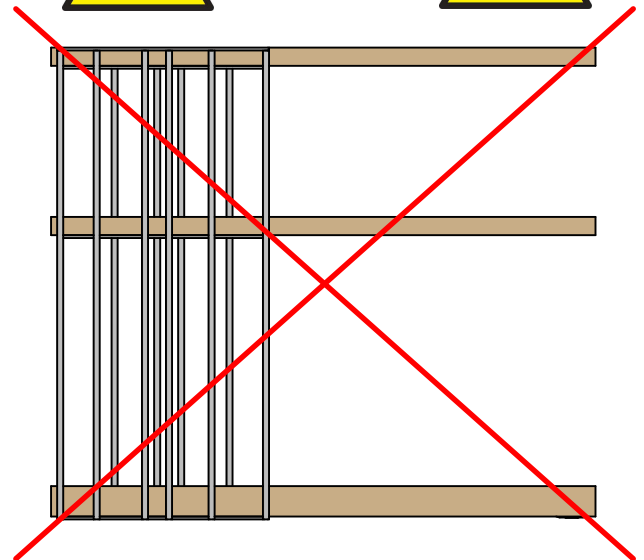

ARSENAL A - B - C



Unione librerie
Bookcase junction
Bücherregal Kreuzung
Bibliothèque jonction
Ensambladura librero

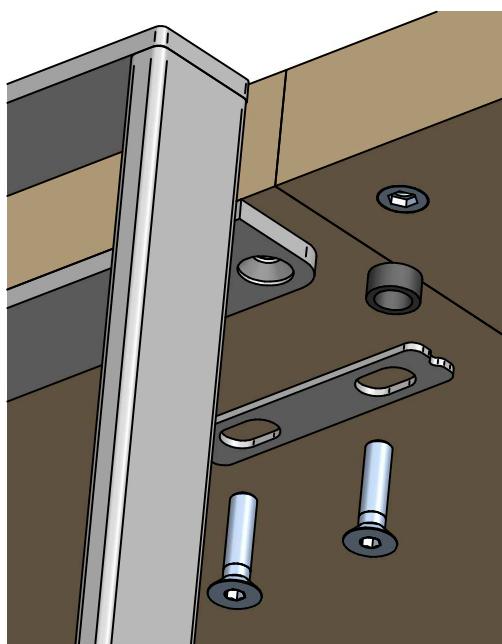
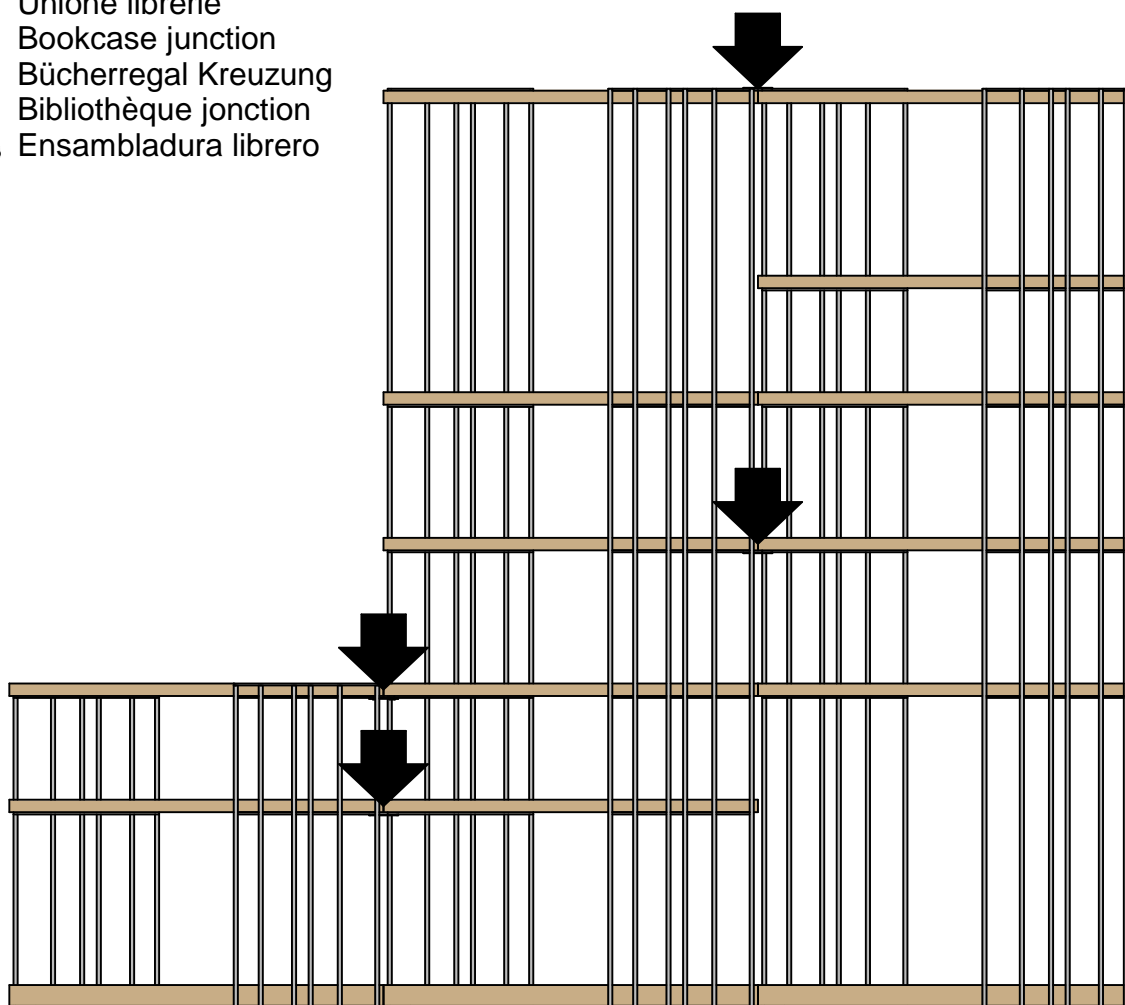

n° 08 TPSCE M6x25 ZB.



n° 04 216414500399.

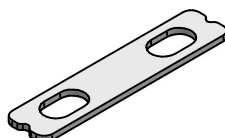

n° 04 pz ø12x6 nero.



n° 01 da 04.

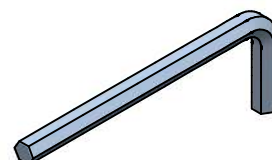

ARSENAL A - B

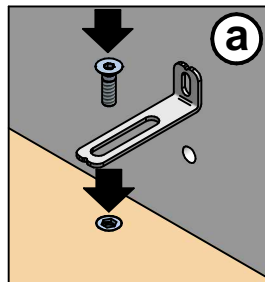
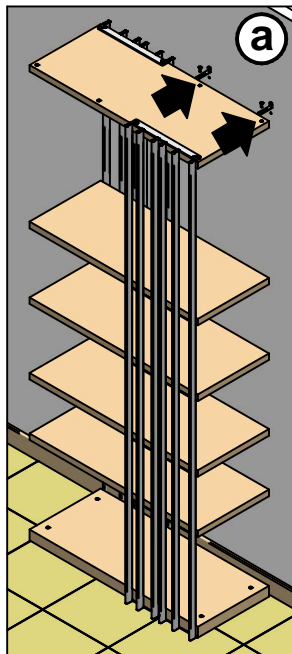

Premontare le squadrette nella parte superiore della libreria.

Preassemble the brackets on the bookcase upper part.

Montieren der Halterungen im oberen Teil der Bibliothek.

Pré-monter les petites équerres dans la partie supérieure de la bibliothèque.

Colocar los soportes en la parte superior de la librería.

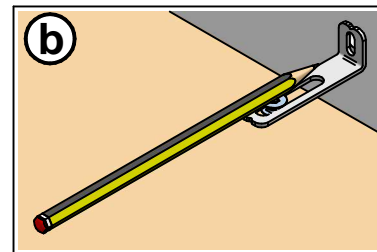
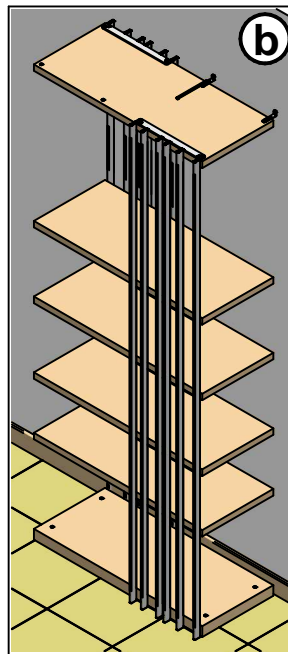

Posizionare la libreria a ridosso del muro, spostare le squadrette a contatto con il muro quindi tracciare le forature con una matita.

Place the bookcase against the wall, move the brackets towards it and draw the drills with a pencil.

Legen Sie die Bibliothek in der Nähe der Wand, bewegen Sie die eckigen Klammern in Kontakt mit der Wand und zeichnen Sie dann die Löcher mit einem Bleistift.

Positionner la bibliothèque près du mur, déplacer les équerres à contact avec le mur et tracer les percements avec un crayon.

Poner la librería cerca de la pared, colocar los soportes en contacto con la pared y marcar los agujeros con un lápiz.

n° 02 TPSCE M6x25 ZB



n°02 cod. 216414500400

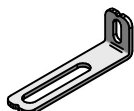

n° 01 da 4.

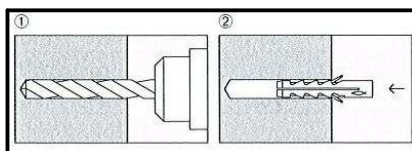
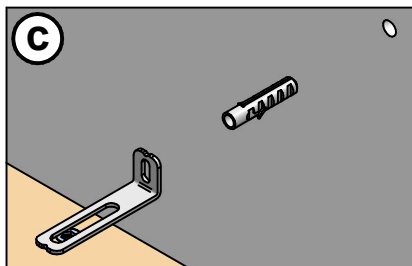
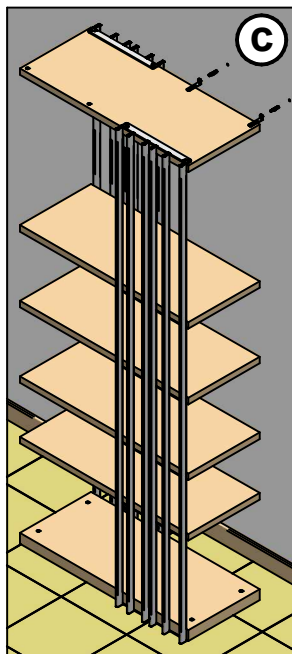

n° 02 pz S6.

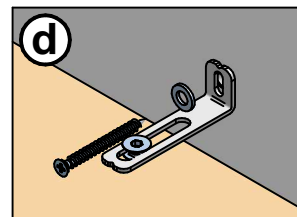
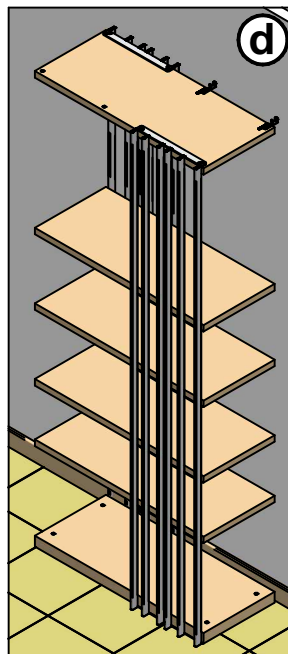

Posizionare la libreria, ancorarla al muro, quindi fissare le viti delle squadrette.

Place the bookcase and fix it to the wall, then fix the screws in the brackets.

Legen Sie die Bibliothek, verankert an der Wand, ziehen Sie die Schrauben der Halterungen.

Positionner la bibliothèque, ancrer-la au mur, donc fixer les vis des équerres.

Posicionar la librería, anclarla a la pared y fijar los tornillos de los soportes.

n° 02 rondella ø6x12 ZB.

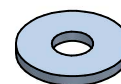

n° 02 TPS croce 3.5x50 ZB.



LIBRERIA SINGOLA CENTRO STANZA O A PARETE
con peso inferiore a 10kg per ripiano non fissare a muro

BIBLIOTHÈQUE CENTRE UNIQUE CHAMBRE OU MUR
la charge en rayon moins de 10 kg ne sont pas fixés jusqu'au mur

LIBRERIA SINGOLA A PARETE
con carico da 10kg a 15kg MAX fissare a parete

BIBLIOTHÈQUE UNIQUE OU MUR
la charge en rayon de 10 kg à 15 kg MAX fixé au mur

BOOKCASE SINGLE OR FIXED TO THE WALL
under a weight of 10kg not fixed to the wall

BOOKCASE SINGLE FIXED WALL
with a load for as low as 10kg up to 15kg MAX fixed to the wall

AVVERTENZE PER IL CLIENTE FINALE

USO

Il prodotto è destinato per l'utilizzo all'interno delle abitazioni con l'uso per il quale è stato realizzato.

REALIZZAZIONE

Il prodotto è realizzato con materiale naturale soggetto alle modificazioni dovute al tempo e all'utilizzo.

MANUTENZIONE LEGNO

Il legno è un materiale vivo e come tale può avere mutamenti nel tempo di colore e di dimensione, gli oggetti che vengono appoggiati sul piano, devono essere spostati periodicamente poiché il legno è sensibile alla luce e si ossida, creando differenze di colore tra le parti esposte alla luce e quelle coperte. Per la normale pulizia utilizzare un panno morbido leggermente umido. Non usare detersivi abrasivi, solventi, ammoniaca, acetone o petrolio. Per la rimozione di macchie utilizzare una soluzione di acqua e sapone neutro, avendo l'accortezza di asciugare subito le superfici bagnate.

ATTENZIONE

Non spostare assolutamente mai il prodotto trascinandolo o sollevandolo prendendolo per il piano ma smontarlo e riposizionarlo dove voluto, assicurandosi di proteggere le parti che si potrebbero danneggiare.

SMALTIMENTO

Una volta dismesso, il prodotto od i suoi componenti non vanno dispersi nell'ambiente ma conferiti ai sistemi pubblici di smaltimento.

Riporre per eventuali consultazioni future.

INSTRUCTIONS FOR THE END CUSTOMER

USE

The product is intended to be used in the inside and for the purposes it was created for.

REALIZATION

The product has been realized with natural material which is subject to modifications produced during time and usage.

MAINTENANCE WOOD

Wood is a living material and therefore susceptible to slight colour and dimension changes. As the wood is sensitive to light and oxidizes, any item standing in the same place on the top for a long period of time can create colour differences between the covered and the exposed parts, so they should be moved periodically. Clean it with a slightly damp soft cloth. **DO NOT** use any chemicals or harsh detergents such as ammonia. To remove stains, wash the top with mild soap and water, and rinse. Dry the top thoroughly.

WARNING

Do not absolutely move the product dragging it or lifting it by gripping the top, but disassemble it and then place it in the new site, protecting the parts that could be damaged.

DISPOSAL

Once discarded, neither the product nor its components should be dispersed in the environment, but rather consigned to public disposal systems.

File for future consultation.

HINWEISE FÜR DEN ENDKUNDEN

NUTZUNG

Das Produkt ist nur für den Innenbereich gedacht. Der Tisch wurde hergestellt, nur als Esstisch genutzt zu werden.

REALISIERUNG

Das Produkt ist in Marmor realisiert. Der Marmor ist ein natürliches Material, das sich im Gebrauch und mit der Zeit ändert.

PFLEGE DES HOLZES

Holz ist ein lebendes Material und kann sich in der Farbe und Grösse ändern. Objekte, die auf die Platte gestellt werden, müssen periodisch bewegt werden, da Holz lichtempfindlich ist und oxidiert und dadurch die Farbe ändert. Für die normale Reinigung genügt ein weiches, feuchtes Tuch. Bitte kein Scheuermittel, Lösungsmittel, Ammoniak, Aceton oder Öl verwenden. Zum Entfernen von Flecken milde Seife und Wasser benutzen, die nassen Oberflächen sofort abtrocknen.

ACHTUNG

Der Tisch absolut nie ziehen oder heben. Falls der Tisch soll bewegt werden, muss zerlegt werden und sorgfältig in der neue Stelle Positioniert. Die empfindliche teile sollen geschützt werden.

ENTSORGUNG

Nach der Aussonderung ist das Produkt und seine Bestandteile nicht selbständig im Freien zu entsorgen, sondern der städtischen Müllabfuhr zu übergeben.

Bitte aufbewahren für eventuelle spätere Nachfragen.

INSTRUCTIONS POUR LE CLIENT FINAL

UTILISATION

Le produit est destiné pour une utilisation à l'intérieur des habitations.

RÉALISATION

Le produit est fabriqué à partir de matières naturelles, par conséquent sensibles au temps et à l'utilisation.

ENTRETIEN BOIS

Le bois est une matière qui vit, et comme tel il peut avoir des changements de couleur, de dimension, les objets posés sur le plateau doivent être posés de façon intermittente car la sensibilité à la lumière peut créer des différences de ton entre les parties du plateau couverte ou non par les objets. Pour l'entretien, utilisez un chiffon doux et légèrement humide. Ne pas utiliser de revêtements abrasif, ammoniacal ou autre détergeant. Pour enlever les taches utiliser de l'eau et du savon neutre, en essuyant immédiatement les parties concernées.

ATTENTION

Ne pas absolument déplacer le produit en le trainant ou en le soulevant par le top, mais démontez-le et positionnez-le autre part, en s'assurant de protéger les parties qui pourraient s'endommager.

ÉCOULEMENT

Une fois déposé, le produit ou ses composants ne doivent pas être dispersés dans la nature mais confiés aux décharges publiques.

A conserver pour les futurs besoins de référence.

INSTRUCCIONES PARA EL CLIENTE FINAL

USO

El producto está destinado para su uso dentro del hogar, a los fines por los cuales fue creado.

REALIZACIÓN

El artículo está realizado con material natural sujeto a las modificaciones causadas por el tiempo y el uso.

MANTENIMIENTO MADERA

La madera es un material vivo y, como tal, puede tener cambios con el tiempo de color y tamaño, los objetos que se colocan en el sobre, se deben mover periódicamente ya que la madera es sensible a la luz y se oxida, creando diferencias de color entre las piezas expuestas a la luz y las cubiertas. Para la limpieza normal, use un paño suave ligeramente humedecido. No use limpiadores abrasivos, disolventes, amoníaco, acetona y aceite. Para quitar las manchas utilizar una solución de jabón suave y agua, asegurándose de secar las superficies mojadas inmediatamente.

ATENCIÓN

No muevan absolutamente nunca el producto arrastrándolo o mediante el levantamiento del plano, sino desmontarlo y llevarlo a donde querían, asegurándose de proteger las partes que pueden dañarse.

ELIMINACIÓN DE DESECHOS

Una vez desechado, el producto o sus componentes no se tienen que abandonar en el entorno sino entregar al sistema público de recogida de basuras.

Guardar para consultas posteriores.

Cattelan Italia spa si riserva di apportare, senza preavviso, modifiche nei materiali, nei rivestimenti, nelle finiture e nei disegni dei prodotti presentati in questo catalogo. Le textures ed i colori dei materiali e delle finiture hanno valore indicativo in quanto soggetti alle tolleranze dei processi di stampa.

Cattelan Italia spa reserves the right to change, without previous notice, materials, covers, finishes and drawings of the products presented in this catalogue. The textures and colours of materials and finishes are indicative as they are depending on the tolerances of the printing process.

Cattelan Italia spa behält sich vor, ohne Vorankündigung, Veränderungen an den Materialien, Bezügen, Finish und Zeichnungen der in diesem Katalog vorgestellten Produkte vorzunehmen. Die Texturen und Farben der Materialien und Finish haben einen hinweisenden Wert, da sie von den Toleranzen im Druckprozess abhängig sind.

Cattelan Italia spa se réserve le droit d'apporter, sans préavis, des modifications au niveau des matériaux, des revêtements, des finitions et du design des produits présentés dans ce catalogue. Les textures et les couleurs des matériaux et des finitions sont une valeur indicative parce-que ils changent selon la tolérance aux procédés d'imprimerie.

Cattelan Italia spa se reserva el derecho de aportar modificaciones de dibujo, materiales, acabados y tapicerías, sin que esté obligada a dar aviso anticipado. Las textures y los colores de los materiales y de los acabados tienen solo un valor indicativo porque están sujetos a la tolerancia en los procesos de imprenta.

IMPORTANTE: Riporre per eventuali consultazioni future!!!!

IMPORTANT: File for future consultation!!!!

WICHTIG: Bitte aufbewahren für eventuelle spätere Nachfragen!!!!

IMPORTANT: A conserver pour les futurs besoins de référence!!!!

¡IMPORTANTE: Guardar para consultas posteriores!

cattelanitalia.com



CATELAN ITALIA spa via pilastri 19 - 36010 Carré / Vicenza - Italy
phone +39 0445 318711 - fax +39 0445 314289 - email: info@cattelanitalia.com